

# FRESKO

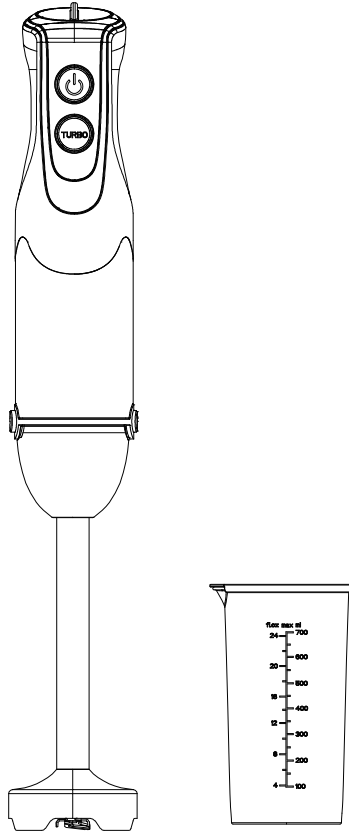

---

## HB3205 Hand Blender

# OPERATION GUIDE

[support@freskoshop.com](mailto:support@freskoshop.com)



# Contents

---

IMPORTANT SAFEGUARDS .....	1-2
PARTS & ACCESSORIES .....	3
TECHNICAL DATA .....	4
PACKAGE CONTENTS .....	4
USING YOUR IMMERSION HAND BLENDER .....	5-7
· IMMERSION HAND BLENDER CONTROLS .....	5
· OPERATING INSTRUCTION FOR BLENDER .....	5-7
RECOMMENDED USE CHART .....	7
PROCESSING GUIDE .....	8
CLEANING AND MAINTENANCE .....	9
TROUBLE SHOOTINGS .....	10
WARRANTY CLAIM PROCEDURE .....	11
ENVIRONMENT FRIENDLY DISPOSAL .....	11

# IMPORTANT SAFEGUARDS

---

Like any electrical appliance, the Immersion Hand Blender must be handled with care at all times. To ensure your own safety, the following precautions should be followed.



1. **BEFORE USING YOUR IMMERSION HAND BLENDER, READ ALL INSTRUCTIONS CAREFULLY.**
2. This product is not intended for people (including children) who are physically impaired, have sensory or mental disabilities, or lack relevant experience and knowledge, unless someone responsible for their safety supervises or directs their use of the product.
3. Keep the product and its cables out of the reach of children.
4. The product is intended for home use. It is not intended for commercial use.
5. Please check if the voltage marked on the product matches the local power supply voltage, before connecting the product to the power supply.
6. Keep power cord away from hot surfaces, sharp objects, or open fire.
7. Do not use this product if the plug, power cord, or product is damaged.
8. Do not submerge the power cord in water.
9. Do not let cord hang over the edge of a table or counter, touch hot surfaces, or become knotted, trapped or pinched.
10. Pulling or stumbling over the power cord can result in tilting over or falling of the appliance, causing serious injury.
11. If this appliance begins to malfunction during use, immediately unplug the cord.
12. Always insert the attachment first, then plug cord into the outlet. To disconnect, switch the appliance off, then remove plug from the wall outlet.
13. Always unplug the appliance from power supply if you leave it unattended. After use and before cleaning, always switch off the appliance and disconnect it from power supply by taking the power cord connector out of the electric socket.
14. Do not immerse the MAIN BODY in water. To protect against electrical shock, do not immerse the cord, power plug, or appliance in any liquid, do not rinse under the tap.
15. Never use the appliance for any other purpose than what is described in this instruction book.
16. For indoor use only. Not intended for outdoor use.

17. The product must be allowed to cool before cleaning.
18. Be careful when handling and cleaning the blades. They are very sharp.
19. Always turn off the appliance and disconnect it from power socket by pulling the power cord, before doing any of the following: replacing accessories or accessible parts that move during operation, cleaning or maintenance, and assembly and disassembly.
20. If the processed food starts to stick to the appliance (e.g. on BLADE, WHISK), switch off the appliance and clean the accessories carefully.
21. Never insert e.g. fingers, fork, knife, spatula, spoon into rotating parts of the appliance or the accessories.
22. Before you remove the appliance or the drive unit from the container, let the rotating parts stop completely.
23. Make sure that your hair, clothes and accessories do not get into close vicinity to the rotating parts.
24. Make sure that the power supply cable does not get between the rotating parts of the accessories.
25. Do not process food at a temperature exceeding about 176 °F. Foodstuffs should not be too hot, as splattering contents may cause scalding.
26. Do not wind the power cord around the appliance, this will reduce its life.
27. This appliance has a polarized plug (one blade is wider than another). To reduce the risk of electric shock, this plug will fit only one way into a polarized outlet. If the plug does not completely fit in the outlet, reverse the plug. If it still does not fit, contact a qualified electrician. Do not modify the plug in any way.
28. If the supply cord is damaged it must be replaced by the manufacturer or a authorized service agent or a qualified technician in order to avoid a hazard.
29. The appliance cannot be used for chopping ice or blending hard and dry substance, otherwise the blade could be blunted.
30. To reduce the risk of injury, never place cutting blade on base without first putting bowl properly in place.
31. The use of accessory not recommended by the manufacturer may cause injuries to persons.
32. Always remove the blade assembly before pouring contents from BEAKER.
33. The BLENDER STICK is made of stainless steel, which has a relatively high hardness. It is not recommended to use it to stir food directly in utensils with non-stick coatings, such as non-stick pans, as this may easily scratch the coating.

**SAVE THESE INSTRUCTIONS FOR HOUSEHOLD USE ONLY**

# PARTS & ACCESSORIES

---

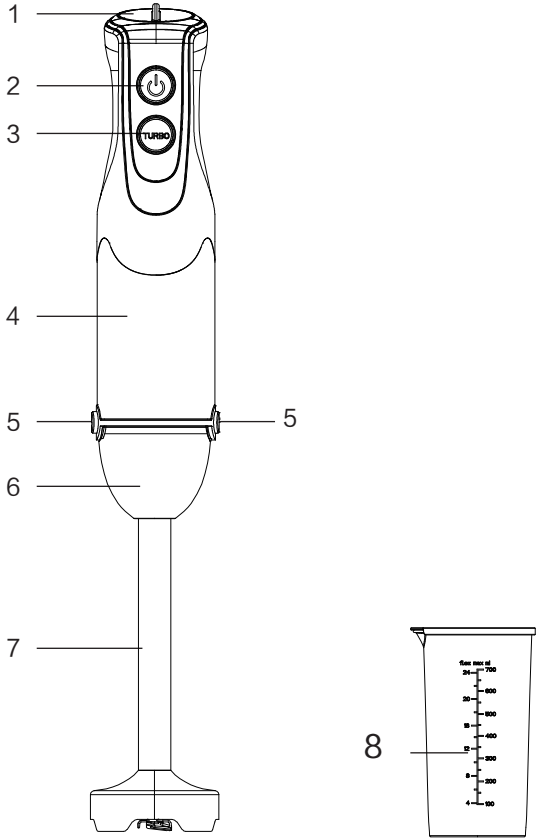

- 1.SPEED DIAL
- 2.POWER BUTTON
- 3.TURBO BUTTON
- 4.MAIN BODY

- 5.RELEASE BUTTON
- 6.BLENDER STICK COLLAR
- 7.BLENDER STICK
- 8.EAKER

## TECHNICAL DATA

---

MODEL NO.:	HB3205
POWER:	120VAC 60Hz 500W
PRODUCT SIZE:	8.5×2.1inches (216×54mm)
NET WEIGHTT:	2 lbs (0.9kg)

## PACKAGE CONTENTS

---

Item	QUANTITY
Main body	1 PC
Blender stick	1 PC
Manual	1 PC
BEAKER (AS)	1 PC

# USING YOUR IMMERSION HAND BLENDER

---

Before the first use, clean the blender according to the section of "Quick cleaning".

 **WARNING:** Sharp blade on BLENDER STICK! Handle with extreme care.

## IMMERSION HAND BLENDER CONTROLS

### 1. SPEED DIAL

Adjusts the blending speed from 1 to 12.  
(With the POWER BUTTON pressed)

### 2. POWER BUTTON

Press and hold to use the Immersion Hand Blender. To stop blending, release button.

### 3. TURBO BUTTON

Press and hold to use maximum power. To stop blending, release button.

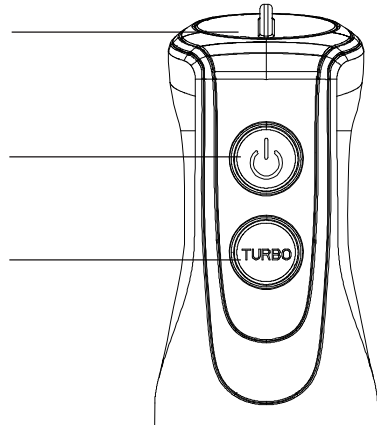

## OPERATING INSTRUCTION FOR BLENDER

 **WARNING:** Do not hold the Power Button for more than 1 minute at a time.



- 1: Place food into the BEAKER. Note: When blending the carrots, cut the carrots into small pieces and put them in BEAKER, then add the water (the ratio of carrots to water is 2:3).

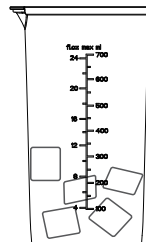



- 2: Align the MAIN BODY with the BLENDER STICK and push the pieces together until you hear and feel them click together. It may be helpful to press the RELEASE BUTTON when assembling.

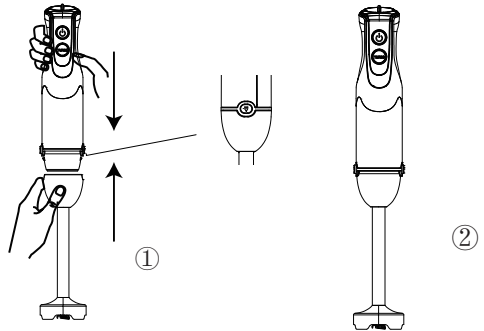

- 3: Plug the Power Cord into power outlet.

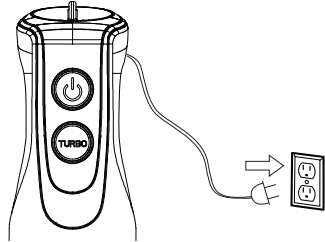

- 4: Lower the blender into food. Then press and hold the low speed button or high speed button to start operating.

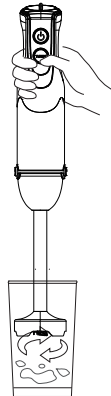

- 5: To stop the blender by releasing the low speed button or high speed button.

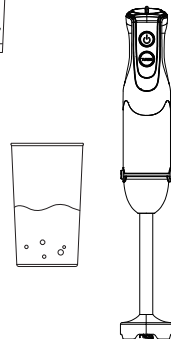

6: Unplug the Power Cord from the power outlet.

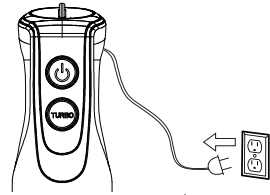

7: To remove, press the RELEASE BUTTON and unplug the BLENDER STICK.

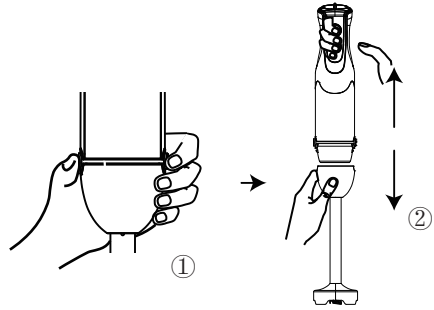

8: When stirring food in non-standard containers (such as: pots or glass bowls, etc.), the knife head can not be exposed to the level of the liquid, otherwise the food liquid will splash.

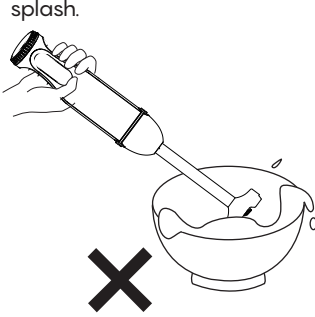

**SPLASH**

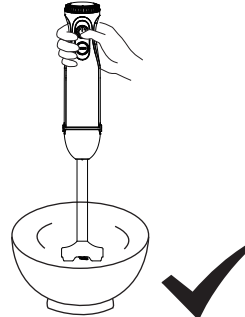

**NO SPLASH**

Note: Items such as pots or glass bowls for operating demonstrations." For operational demonstration only, not standard with the product"











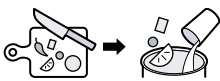
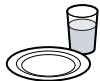



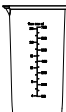



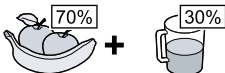

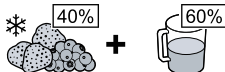
## RECOMMENDED USE CHART

For better results, please add enough liquid to improve the fluidity of solid foods before blending.

ACCESSORY	USEFUL FOR
BLENDER STICK	Soups Sauces Mayonnaise Smoothies Milkshakes Baby food

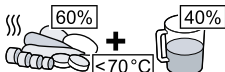
Refer to the table below for guide on recommended use for different food types

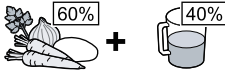
# PROCESSING GUIDE (FOR 700ML BEAKER)

			 MIN-MAX	 00:00	
  			200-300 g	60 s	
			200-300 g	60 s	
			200-300 g	60 s	
			1 x 0	60 s	
			200-300 g	60 s	
			200-300 g	60 s	

# CLEANING AND MAINTENANCE

---



**NOTE:** Do not immerse the MAIN BODY in water.









**NOTE:** Do not immerse the detachable stem of the blender in water because overtime the lubrication on the bearings may wash away.

This appliance requires little maintenance. It contains no user serviceable parts. Do not try to repair it yourself. Contact the Customer Service Department for any unusual issues you may experience.

1. Always unplug the Immersion Hand Blender before cleaning.
2. Ensure the Immersion Hand Blender has cooled down before cleaning.
3. Be very careful when cleaning BLENDER STICK blades, the blades are very sharp.
4. To clean MAIN BODY, wipe down with a clean, damp cloth and dry thoroughly after every use. Never submerge in water or other liquids. DO NOT place BLENDER STICK COLLAR in water.
5. Never use harsh chemical detergents, powder or scouring pads on any of the parts.
6. To clean all detachable parts and accessories, wipe with a soft cloth and a mild detergent before rinsing again. Soak in hot water for a few hours for easy cleaning. Then wipe down with a damp cloth and allow to dry.
7. Do not place the Immersion Hand Blender, or any of its attachments in the dishwasher, as this will damage internal components. Do not use abrasive cleaners.
8. Store Immersion Hand Blender in a clean, dry place.
9. Contact Customer Service for any issues or malfunctions.

### Quick cleaning

Between processing tasks, hold the hand blender in the beaker half filled with water and turn on for a few seconds.

			
	✓	✗	✗
	✓	✗	✓
	✓	✓	✓
	✓	✓	✓

## TROUBLE SHOOTINGS

Problem	Case of problem	Solution
The machine doesn't work	The whole machine does not work and has no power.	Check whether the power cord plug position, pressed in place to check whether to send the opening.
	The mixing rod and the MAIN BODY can not be assembled.	Check the mixingrod and the MAIN BODY need to be aligned with the silk screen solution position and the knob is in place as required .

# WARRANTY CLAIM PROCEDURE

---

To ensure quick processing of your case, please observe the following instructions: Please have the till receipt and the item number (S/N: 1 2345) available as proof of purchase.

You will find the item number as a sticker on the rear or bottom of the appliance.

If malfunctions or other defects occur, please contact our customer service listed either by telephone or by email.

If you request any further assistance, please contact us:

Customer service: [support@freskoshop.com](mailto:support@freskoshop.com)

# ENVIRONMENT FRIENDLY DISPOSAL

---

## Disposal:



Guideline 2012/19/EC concerning the handling, collection, recycling and disposal of electrical and electronic equipment and their components 'waste electrical and electronic equipment', known as WEEE"

The crossed symbol on a rubbish container indicates that the machine or device is not allowed to be disposed of, but must be handed over to an appropriately equipped collection point for proper recycling or disposal.



The packaging materials have been selected for their environmental friendliness and ease of disposal and are therefore recyclable. Dispose of packaging materials that are no longer needed in accordance with applicable local regulations.



# FRESKO

**Manufacture: Bonsen Electronics Limited**

📍 : No. 11, Lunpinchong Industrial Zone, Houjie Town,  
Dongguan City, Guangdong Province, China,  
postal code 523941.

✉ : [support@freskoshop.com](mailto:support@freskoshop.com)

☎ : 1-866-211-9344

**Made in China**